

**YASHICA** Pentamatic

INSTRUCTION BOOKLET

F1.8

## Description of the YASHICA PENTAMATIC

### This is your YASHICA PENTAMATIC

A precision instrument capable of bringing you the finest photographs you have ever taken.

#### IMPORTANT : Care of Camera and Lens

The outer parts of the camera body should be cleaned with soft linen. The inside of the camera body should be cleaned with a soft brush or hand blower with care, never use a frayed cloth. It is most essential to keep the film pressure plate clean.

When cleaning the lens, alcohol may be used but great care must be exercised to prevent excessive amounts of alcohol from attacking the balsam adhesives between the lens elements.

Special care should be exercised when cleaning the mirror surface not to apply undue pressure.

During production special oils are used to permanently lubricate the moving parts of the camera. These special oils do not mix well with ordinary oils and, therefore, it is not necessary nor advisable to oil the camera.

Do not dismantle the camera or the lenses; leave this precision work to expert camera repairmen.

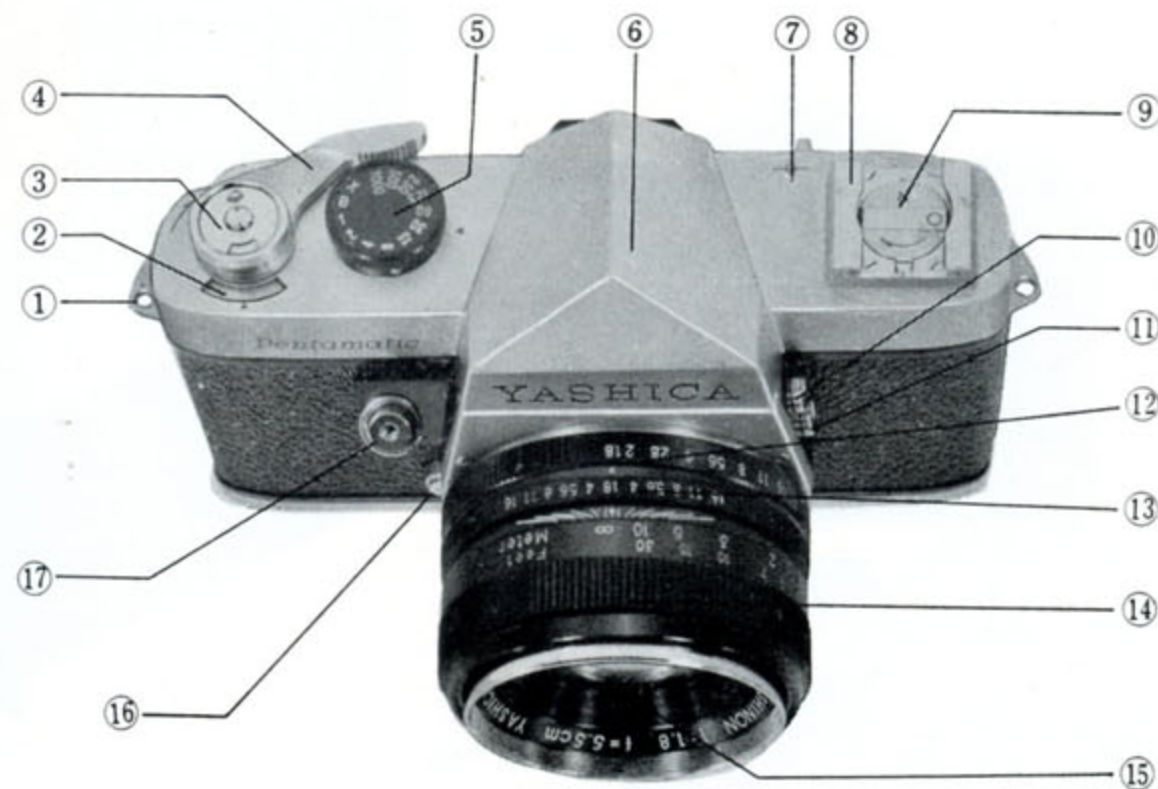

**YASHICA Pentamatic 35<sub>mm</sub> Single lens Reflex**

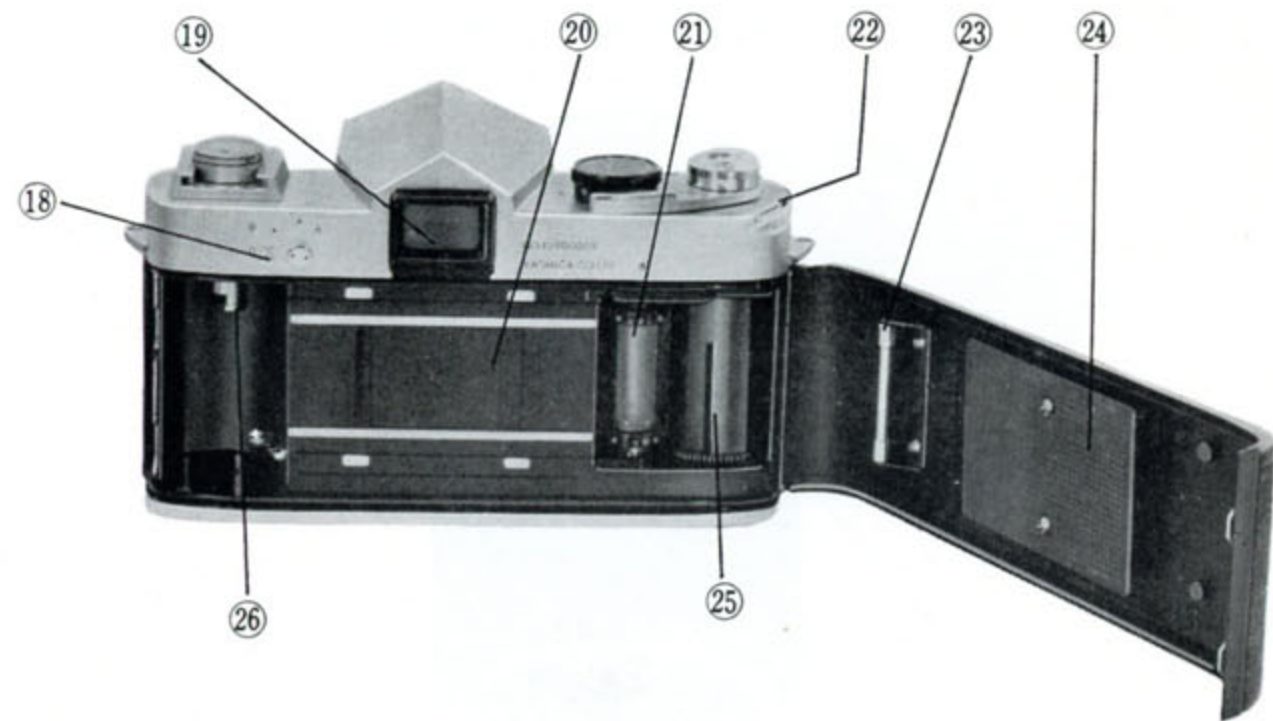

- |                          |   |
|--------------------------|---|
| 1. Strap Holder          | 7. Film position Mark                         |
| 2. Film Exposure Counter | 8. Accessory Shoe                             |
| 3. Film Load Reminder    | 9. Rapid Film Rewinder and Back Cover Release |
| 4. Film Advance Lever    | 10. Focal Plane Flash Terminal                |
| 5. Shutter Speed Dial    | 11. "X" Synchro-terminal                      |
| 6. Pentaprism Housing    | 12. Aperture Control Ring                     |

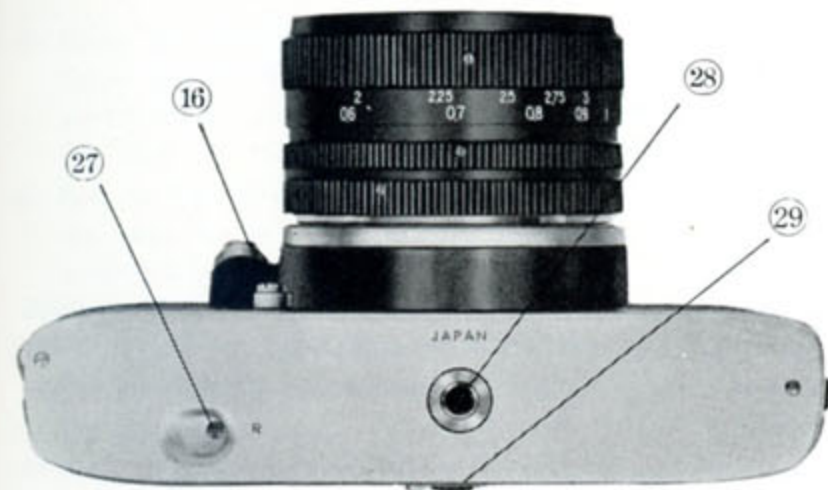

- |   |
|---|
| 13. Depth-of-field Scale  |
| 14. Focusing Ring   |
| 15. AUTO YASHINON f: 1.8 Lens   |
| 16. Lens Release Button   |
| 17. Shutter Release Button  |
| 18. Film Rewind Knob and Back Cover Release Lever (in "Open Back" position) |
| 19. Eye-level Pentaprism View/rangefinder Eye-piece                         |
| 20. Shutter Screen  |
| 21. Sprocket  |
| 22. Exposure Counter Reset Wheel  |

- |                                  |
|----------------------------------|
| 23. Film Pressure Roller         |
| 24. Film Pressure Plate          |
| 25. Take-up Spool                |
| 26. Cassette Supporting Shaft    |
| 27. Release Button for Rewinding |
| 28. Tripod Socket                |
| 29. ASA Film Speed Reminder      |
| 30. Diaphragm Control Lever      |
| 31. Lens Locking Pin             |
| 32. Instant Return Mirror        |
| 33. Top-dead-center Indicator    |



## LOADING FILM

35mm roll film  
20 or 36 exposures per roll  
24×36 mm size negative  
Black and White or Color

- 1) Move the Back Release Lever to the 'O' position. The Film Rewind Knob will pop up at the 'R' position but should not be pulled out further until the Back Release Lever is moved to 'O'; the Film Rewind Knob can now be pulled out further to open the back of the camera.
- 2) Place the film cartridge or loaded film cassette in the left chamber so that the cassette projection fits into the slot of the rewind shaft. Put the Back Release Lever at 'R' and push the Film Rewind Knob in; the cassette is now securely in position.
- 3) Rotate the Take-up Spool until the groove in the spool is positioned so as to allow the film leader to fit into the groove.

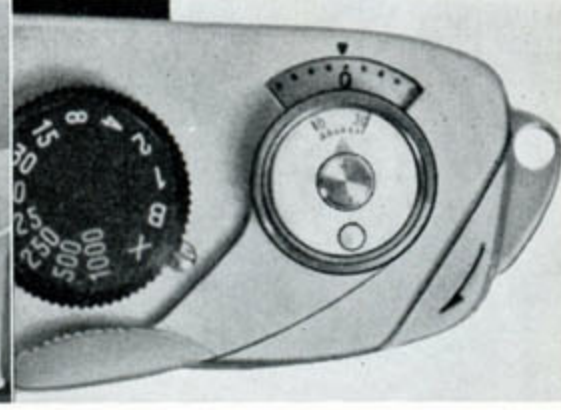
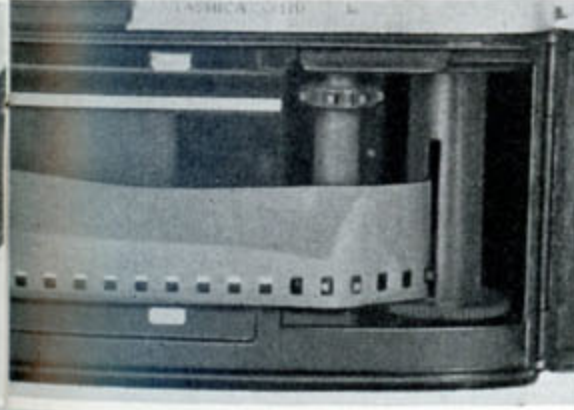
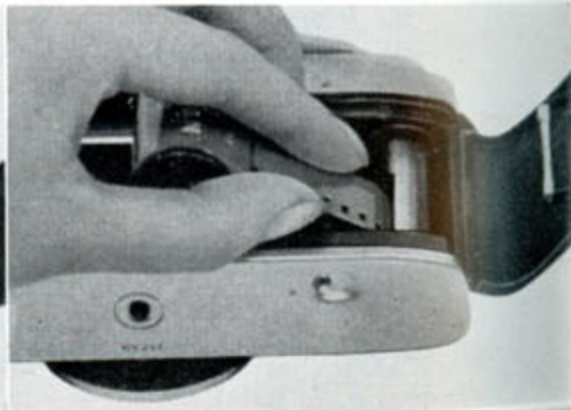
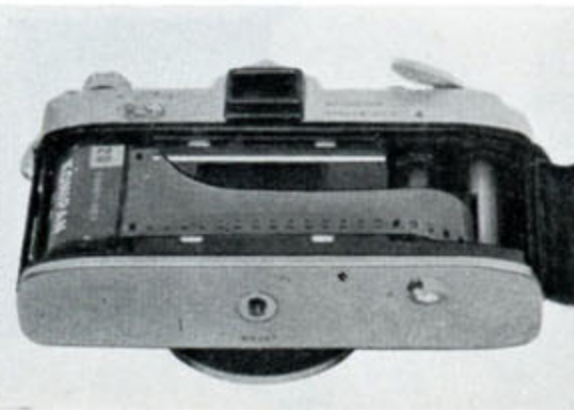
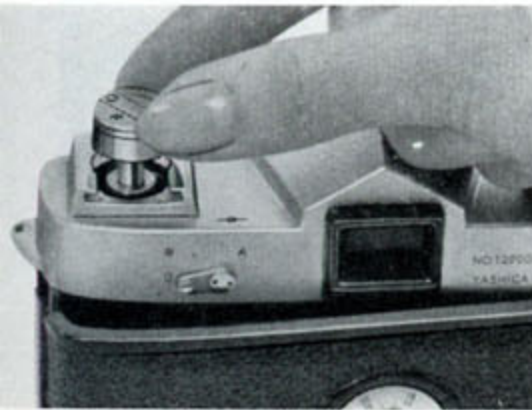

- 4) Draw out about 6 inches (15 cm) of film, place the end well into the Take-up Spool and fit the sprocket hole over the protruding pin. Position the film perforations over the teeth of the Take-up Spool Sprocket and pull the film taut by slowly moving the Film Advance Lever.
- 5) Put the Film Rewind Lever in position 'A' and push the Film Rewind Knob all the way in; a slight rotating movement is sometimes required. Close the camera back, it will automatically lock in position, and advance the film three times. Set the Film Counter to 'zero' by moving the Manual Reset Wheel.
- 6) The camera is now ready to make first picture. On the next film advance, the shutter will be cocked and the film counter advanced by one.
- 7) The Loading Reminder should be set at the appropriate number to remind you of the number of exposures which have been loaded into the camera; standard cassettes of 20 and 36 exposures or bulk loaded cartridges, up to 40 exposures, can be used. A handy Film Speed Reminder permits you to set the type of film, black and white or color, and the film speed on one easy-to-read dial. The red line on the inner dial should be set in the upper position for color film and the film speed aligned by turning the outer ring. The black line on the inner dial should be set in the upper position for black and white film and the film speed aligned by turning the outer ring.

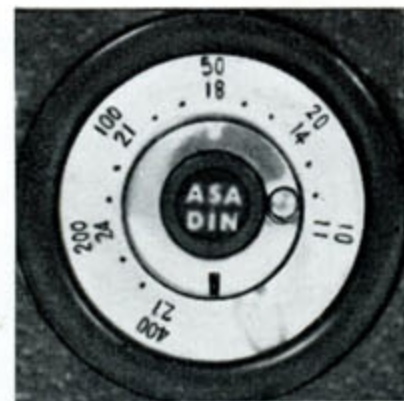

## UNLOADING FILM

After taking a full roll of film, it is necessary to rewind the film into the cassette or cartridge before removing the exposed film from the camera.

- 1) Release the film for rewinding by pressing the Release Button.
- 2) Move the Film Rewind Lever to position 'R', raise the rewind crank and rewind the film by turning the crank clockwise. The film is completely rewound when the resistance is no longer felt. It is not necessary to hold the Release Button down while rewinding.
- 3) Move the Film Rewind Lever to position 'O' and pull the Film Rewind Knob out to its fullest extent; this action releases the back cover and the film can be removed from the camera.

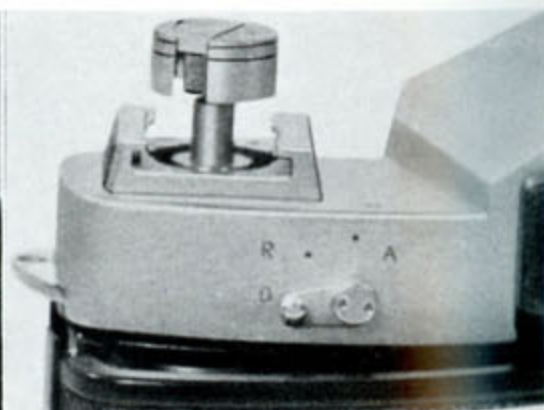
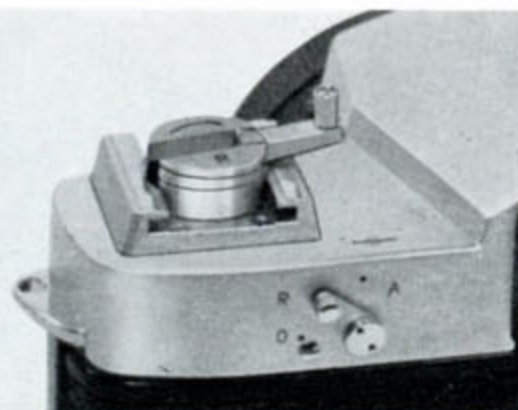
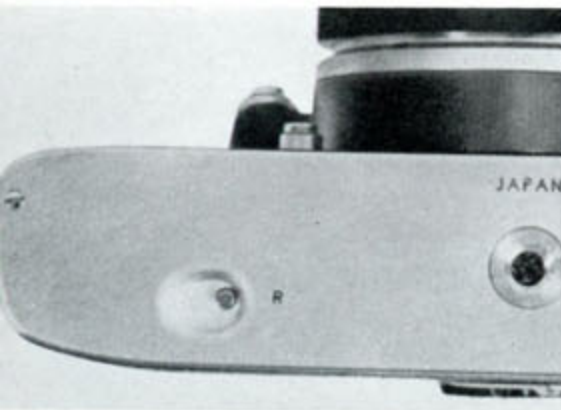

### Note :

*Toward the end of the film you will feel a slight resistance. But continue turning the rewind crank until the film pulls away from the slot on the Take-up Spool.*

## VIEWING AND FOCUSING

Viewing, focusing and picture taking are all done through a single window. There is never any question about parallax correction as you always see the picture exactly as it will be recorded on the film. The PENTAMATIC utilizes fresnel viewing screen for the brightest focusing picture and the focusing is not complicated by having to line up a split image which very often becomes an arduous task when a diffused subject is being photographed. You have only to bring the subject into clear focus by rotating the focusing ring and then snap the picture.

In addition to focusing, there are two other basic adjustments on any fine camera : the lens aperture and the shutter speed.

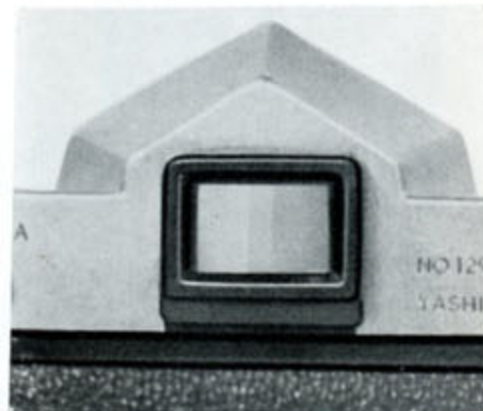

## LENS OPENING

The lens opening or aperture controls the amount of light that will pass through the lens and onto the light sensitive film. Your YASHICA PENTAMATIC, with its AUTO YASHINON lens, offers openings at f : 1.8 2 2.8 4 5.6 8 11 16. Notice that the lower the number, the larger the opening. F : 1.8 is the largest opening and f : 16 is the smallest.

To set the lens opening, move the Aperture Control Ring to the desired setting by aligning it with the red dot next to the Aperture Control Ring.

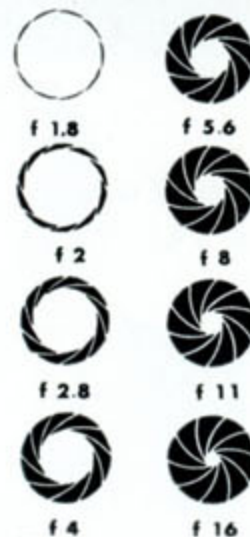

## SHUTTER SPEED

The shutter speed controls the duration of the exposure. Shutter speeds on your YASHICA PENTAMATIC with its extremely accurate focal screen shutter are, 1 1/2, 1/4, 1/8, 1/15, 1/30, 1/60, 1/125, 1/250, 1/500, 1/1000 of a second, Bulb and 'X' (electronic flash). The Bulb, or 'B', setting is for taking pictures with an exposure longer than one second. (See page 15 for using self timer). A tripod or other brace should always be used to support the camera when using 'B'. When the Shutter Release Button is depressed and the Shutter Speed Dial is set at 'B' the shutter will remain open until the button is released.

Camera may be Hand held	
Average Pictures	Action Pictures
'X' 1/60, 1/125	1/250, 1/500, 1/1000

Use a Tripod or Brace	
Time Exposure	Slow Speed
'B'	1 sec., 1/2, 1/4, 1/8, 1/15, 1/30

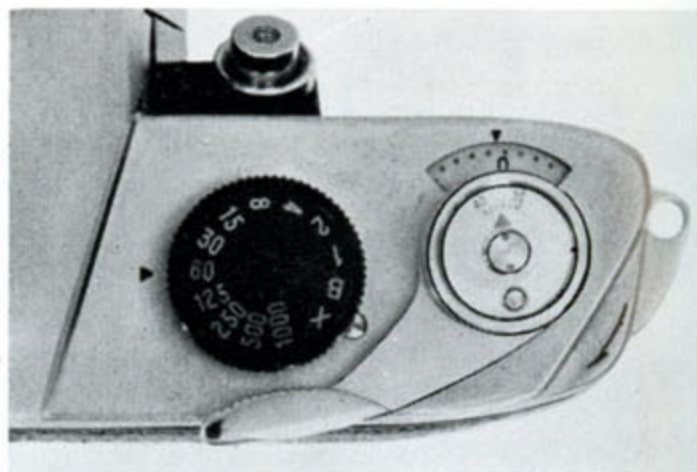

## PICTURE TAKING

- 1) Determine the correct exposure combination to be used for the particular scene to be taken.
- 2) Turn the inner ring of the lens barrel, Aperture Control Ring, to the desired stop.
- 3) Set the shutter speed by rotating the Shutter Speed Dial in either direction until the desired shutter speed is lined up with the small black triangle on the camera top.

Note : The green numbers on the Shutter Speed Dial indicate that hand-held operation is possible, the white numbers indicate that hand-held operation is not recommended and that a tripod or other steady base should be used. The red 'X' is used for electronic flash, the shutter speed is approximately 1/60 of a second but the duration of the electronic flash actually determines the exposure time.

- 4) Advance the Film Advance Lever until it stops thereby bringing the next unexposed section of film into place and cocking the shutter. The Film Advance lever can be moved either by a single full movement or by small short successive movements. **IMPORTANT :** Be certain the lever travels through its full movement or otherwise the shutter will not cock.



- 5) Regardless of the pre-set aperture setting, the aperture is now fully open and the subject is clearly visible through the pentaprism viewer. Bring the subject into clear focus by rotating the Focusing Ring.

Note: If you have set an aperture opening of  $f:16$  and have not cocked the shutter, your view through the finder will seem dark and when focused on to a subject the depth of field will be discernible. Other object in front and behind the subject will be of acceptable sharpness within the range thus enabling you to determine the aperture opening best suited for your picture. In order to open the aperture for clear viewing and focusing it is essential that the shutter be cocked. When the picture is taken the aperture automatically stops down to the pre-set aperture setting.

- 6) Press the Shutter Release Button

Note: The shutter speed setting can be changed either before or after the film has been advanced and the shutter cocked.

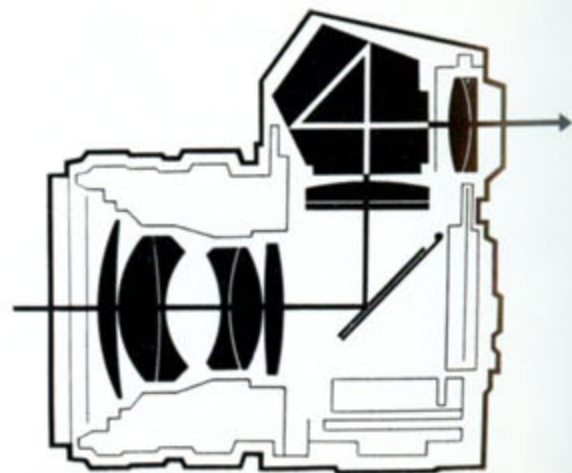

## DEPTH OF FIELD

When you focus the camera on a subject there is a certain distance in front and back of the subject within which other object will also appear sharp. This is known as the "Depth-of-Field", and it varies with the lens aperture, the smaller the aperture the greater the Depth-of-Field; it is much larger at  $f:16$  than at  $f:1.8$ .

The Depth-of-Field Scale will be found on the lens mount in the front part of the camera.

You will notice that on either side of the  $f:1.8$

figure is a similar set of numbers which represent the lens apertures. When the camera is focused on your subject, look for the aperture you are using on either side of the scale to determine the Depth-of-Field. Thus, if the camera is focused at 10 feet and the lens aperture is  $f:16$ , the Depth-of-Field (area in which all objects are sharp) is from about 7 ft. to 20 ft.



You can also use the Depth-of-Field to use your Yashica PENTAMATIC as a fixed-focus camera. In this case set the distance scale to 20 ft., and the lens aperture to  $f:8$ . You will notice on the Depth-of-Field that anything from about 11 feet to infinity will be in focus.

## INFRARED PHOTOGRAPHY

Associated with the Depth-of-field Scale you will find a small red dot to the right of the Lens Aperture setting indicator. This mark is used for focusing the camera when infrared film is being used.

Most lenses are calibrated for normal white light and the different wave length of infrared light must be taken into consideration when using this medium ; a corrective adjustment of the focusing ring permits accurate setting for infrared wave length.

The camera is readied for use in the normal manner. After the subject distance has been determined, the camera to subject distance must be further aligned with this red dot.



INDEX For  
INFRARED PHOTOGRAPHY  
DEPTH-OF-FIELD SCALE INDEX

## FLASH SYNCHRONIZATION

Two separate terminals are provided for flash synchronization. The upper terminal should be used flash bulb operation. The synchronization is fully automatic for all shutter speeds ; no adjustments are required



The lower terminal should be used for electronic flash synchronization. When using a stroboscopic or other electronic flash unit, you should always put the Shutter Speed Dial at the red 'X', this assures you of proper synchronization. The shutter speed will be approximately 1/60 of a second but the actual exposure time will depend on the duration of the strobo flash.





## CABLE RELEASE AND SELF-TIMER

Any standard/tapered plunger-type cable release can be used with the YASHICA PENTAMATIC by simply attaching the release to the Shutter Release Button.

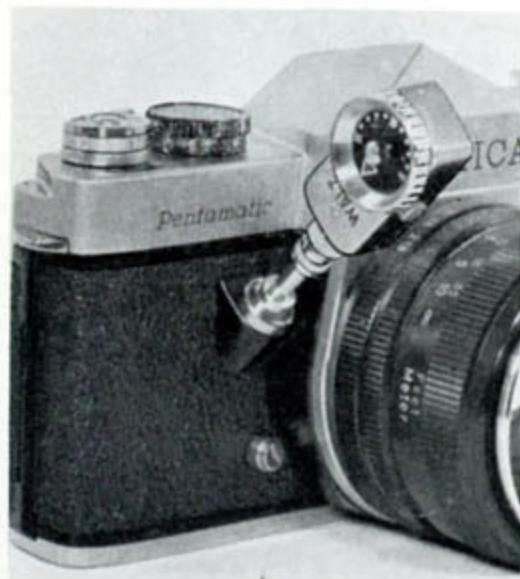

Standard self-timers can also be screwed into the Shutter Release Button. A built-in self-timer was not considered versatile enough for the general needs of the photographer and, therefore, provisions were made for using an accessory self timer.

## CHANGING LENSES

To interchange the line of Yashica lenses available for the PENTAMATIC, you need only press in on the Lens Release Button and rotate the lens counter-clockwise about one third of a turn and the lens slips off the camera. Other lenses are installed by matching the longer flange of the lens with the longer slot of the lens mount and then rotating 1/3 of a turn, clockwise.

Lenses of other manufacture can be installed by use of adapter rings. Select the adapter ring which accepts the mount of the desired lens and put it on the camera as you would a standard Yashica lens. Any accessory lens with a mount which matches this adapter can now be installed in accordance with the manufacturer's instructions for the lens.

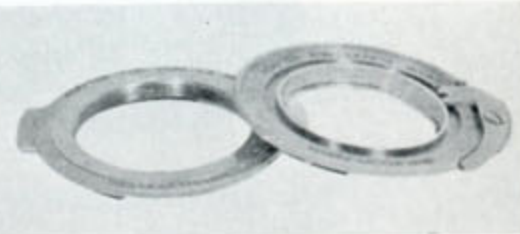
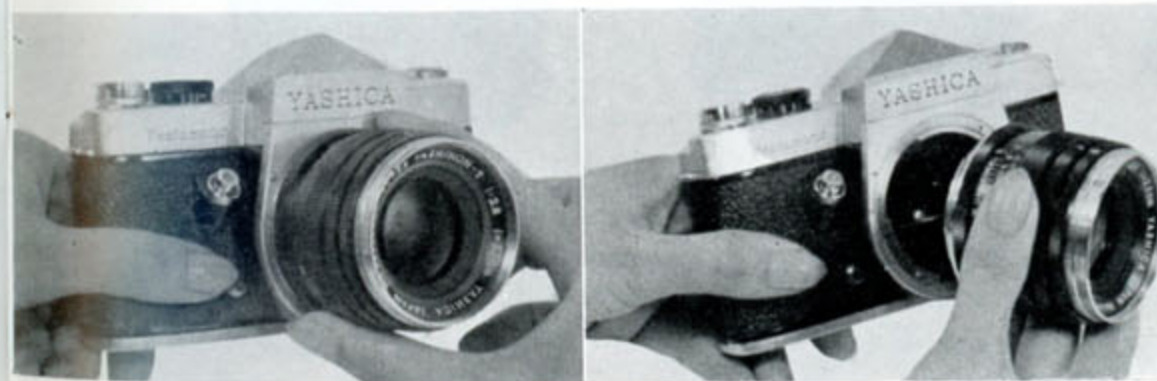

Adapter Ring for Exacta Mount & Praktika Mount

## ACCESSORIES FOR YASHICA PENTAMATIC

A full range of accessories are available for your YASHICA PENTAMATIC including extra lenses, filters, lens shades and professional equipment such as copying unit and oscilloscope adapters.

### Lenses Available for the PENTAMATIC



**AUTO YASHINON**  
f: 1.8 55mm, fully automatic, color corrected, hard coated, bayonet mount.



**YASHINON WIDE ANGLE**  
f: 2.8/35mm, pre-set, color corrected, hard coated bayonet mount.



**YASHINON TELEPHOTO**  
f: 2.8/100mm, pre-set, color corrected, hard coated, bayonet mount.

## FILTERS

Monochrome Filters :

screw-in mount, designed to fit all Yashica PENTAMATIC lenses, diameter 52mm.



\* Yellow (Y2) \* Red (R1) \* Blue (B) \* Green (G1) \* Orange (O2) \* Ultra-Violet (U-V).

Color Conversion\* Filters :

Screw-in mount, designed to fit all Yashica PENTAMATIC lenses.

1A, Skylight	to reduce excessive blue light
80 B	for use of daylight film with photofloods
81 B	for cloudy or hazy days
82 B	for early morning and late afternoon
85 C	for tungsten film in daylight

## **PROFESSIONAL EQUIPMENT**

**Copying Unit**



**Oscilloscope Adapter**



**Extension Bellows**

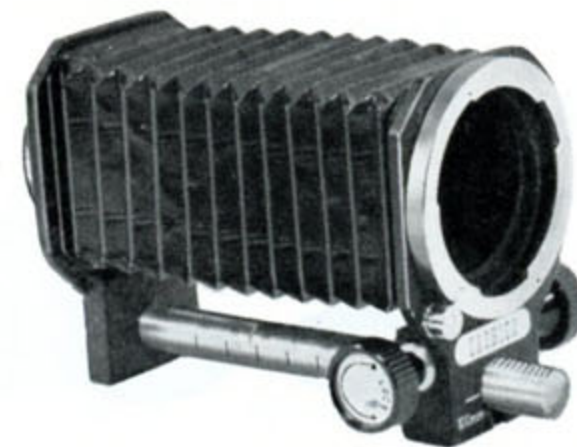
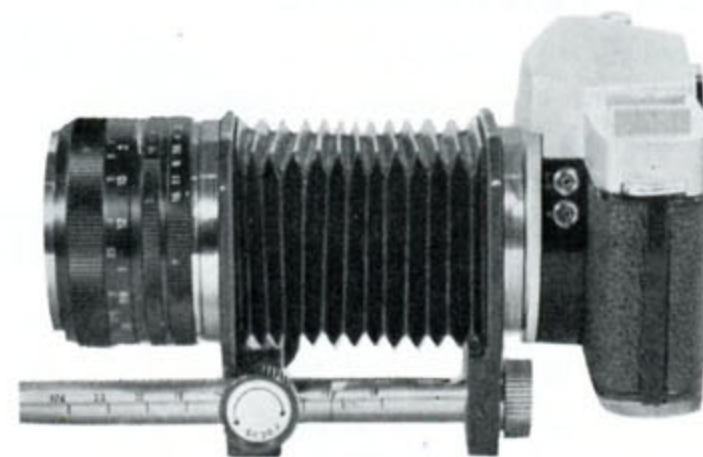

**Microscope Adapter**



## EXTENSION TUBES FOR YASHICA PENTAMATIC

There are 4 types of the Rings available for the YASHICA PENTAMATIC, and close-up data to be acquired by appropriate selection and fitting together of the tubes on the Auto Yashinon standard lens at the closest focus distance are as follows:

Extension Tubes	Length	Repro Ratio	Area Photographed
Adapter Rings only	7.5 mm	0.07	343 × 514
Adapter Ring +No. 1	13 mm	0.12	200 × 300
" +No. 2	18.5 mm	0.18	133 × 200
" +No. 1 +No. 2	24 mm	0.23	104 × 157
" +No. 3	29.5 mm	0.28	86 × 129
" +No. 1 +No. 3	35 mm	0.34	71 × 106
" +No. 2 +No. 3	40.5 mm	0.39	62 × 92
" +No. 1 +No. 2 +No. 3	46 mm	0.44	55 × 82
" +No.1 × 2 +No.2 +No.3	51.5 mm	0.50	48 × 72



## ADAPTER RINGS



Ring No. 1.

Used to attach lenses utilizing the 'PRACTIKA' or 'ASAHI-PENTAX' type mounts.

Ring No. 2.

Used to attach lenses utilizing the 'EXACTA' type mounts.



## LENS HOOD



In order to prevent flare as well as harmful reflection of light within the lens barrel which will spoil the pictures, use of lens hood is recommendable.

The lens hood can be attached to the lens by slipping it on and tightening the set-screw so that it can be fitted over the lens.

### DEPTH OF FIELD SCALE IN FEET

Ft. \ F	1.8	2.0	2.8	4.0	5.6	8.0	11	16	22
2	1' 11" 2' 0"	1' 11" 2' 0"	1' 11" 2' 0"	1' 11" 2' 1"	1' 11" 2' 1"	1' 11" 2' 2"	1' 11" 2' 2"	1' 10" 2' 3"	1' 9" 2' 4"
3	2' 11" 3' 1"	2' 11" 3' 1"	2' 11" 3' 1"	2' 11" 3' 1"	2' 10" 3' 2"	2' 10" 3' 3"	2' 9" 3' 4"	2' 7" 3' 6"	2' 6" 3' 9"
5	4' 10" 5' 2"	4' 10" 5' 2"	4' 10" 5' 3"	4' 8" 5' 4"	4' 7" 5' 6"	4' 5" 5' 9"	4' 3" 6' 1"	3' 11" 6' 8"	3' 8" 7' 8"
7	6' 8" 7' 4"	6' 8" 7' 4"	6' 7" 7' 6"	6' 5" 7' 8"	6' 2" 8' 0"	5' 11" 8' 7"	5' 7" 9' 4"	5' 1" 11' 0"	4' 8" 14' 0"
10	9' 5" 10' 7"	9' 5" 10' 8"	9' 2" 11' 0"	8' 10" 11' 6"	8' 5" 12' 2"	7' 11" 13' 6"	7' 4" 15' 7"	6' 7" 20' 11"	5' 10" 108' 0"
15	13' 9" 16' 6"	13' 8" 16' 7"	13' 2" 17' 5"	12' 6" 18' 8"	11' 10" 20' 8"	10' 10" 24' 10"	9' 9" 32' 9"	8' 5" 70' 11"	7' 2" ∞
30	25' 6" 36' 6"	25' 0" 37' 5"	23' 6" 41' 6"	21' 6" 49' 8"	19' 4" 67' 6"	16' 8" 145' 0"	14' 4" ∞	11' 7" ∞	9' 5" ∞
inf.	167' ∞	150' ∞	107' ∞	75' 2" ∞	53' 8" ∞	37' 7" ∞	27' 4" ∞	18' 9" ∞	13' 8" ∞

### DEPTH OF FIELD SCALE IN METER

m \ F	1.8	2.0	2.8	4.0	5.6	8.0	11	16	22
0.5	0.50 0.50	0.50 0.50	0.49 0.51	0.49 0.51	0.49 0.51	0.48 0.52	0.47 0.53	0.46 0.54	0.45 0.56
1.0	0.98 1.02	0.98 1.02	0.97 1.03	0.96 1.04	0.95 1.06	0.92 1.09	0.90 1.13	0.86 1.20	0.82 1.29
1.5	1.46 1.54	1.45 1.55	1.44 1.57	1.41 1.60	1.38 1.65	1.33 1.72	1.23 1.81	1.20 2.01	1.11 2.30
3.0	2.84 3.18	2.82 3.21	2.75 3.30	2.66 3.44	2.54 3.66	2.39 4.04	2.22 4.64	1.98 6.17	1.76 10.20
5.0	4.56 5.54	4.51 5.60	4.34 5.89	4.11 6.38	3.84 7.16	3.49 8.80	3.14 12.30	2.68 36.50	2.29 ∞
10.0	8.37 12.40	8.22 12.80	7.67 14.40	6.97 17.70	6.22 25.50	5.35 75.70	4.56 ∞	3.66 ∞	2.95 ∞
inf.	50.90 ∞	45.80 ∞	32.70 ∞	22.90 ∞	16.40 ∞	11.50 ∞	8.32 ∞	5.73 ∞	4.17 ∞

### Notice !

Be sure to replace the lens Cap when your camera is not in use. Keep your camera away from dust and moisture. For cleaning the lens surface to remove dust or dirt, always wipe very lightly by using clean gauze or lens cleaning cloth. Do not wipe the lens with a dirty handkerchief. When you are not using your camera for a long period do not leave the shutter set.

### REVIEW :

- a Select your exposure combination
- b Set the lens opening (aperture)
- c Set the shutter speed
- d Cock the shutter
- e Compose your picture through the viewfinder
- f Take the picture

### CAMERA IDENTIFICATION

As soon as possible after you purchase your Yashica Pentamatic, fill in the information required below. Keep this booklet in a safe place. In case of loss or theft this information may prove valuable in recovering the cameras.

YASHICA Serial Number \_\_\_\_\_

AUTO YASHINON f : 1.8/55 mm Lens Number \_\_\_\_\_

PURCHASED at \_\_\_\_\_  
(Name of Firm)

\_\_\_\_\_  
(Address)

DATE of PURCHASE \_\_\_\_\_



YASHICA CO., LTD.

Printed in Japan